

# FieldTAP

10M/100M/1000M (1G) | USB monitor ports | Troubleshooting



## Field Testing and Monitoring Solution

Visibility starts with the packet. Network test access points (TAPs) are purpose-built, non-intrusive hardware devices that copy 100% of your networks data allowing your monitoring tools to see every bit, byte and packet.®

These pocket-sized portable network TAPs are ideal for 10M/100M or 10M/100M/1G field test monitoring and are great for field engineer troubleshooting capabilities. These highly efficient TAPs are a must-have item for any network trouble-shooting tool kit, to easily check an internet connection, network connectivity, and tapping a link on-the-go.

## Key Features





- Collect full-duplex 1G (2Gbit) of traffic
- Monitoring on USB 3.0
- Network Aggregation
- USB3 powered or with external power supply
- Pocket sized "mini" TAP
- Also available in portable form-factor with 1U rack mount; holds up to 4 TAPs
- Invisible to the network. 100% secure and invisible; no IP address, no MAC address, cannot be hacked
- Failsafe technology
- Passes PoE (Power over Ethernet)
- Passes physical layer errors
- Link failure propagation (LFP)
- Link speed synchronization
- Supports Jumbo frames
- Easy to configure with switches on back, with durable steel construction
- Made, tested and certified in the USA

## APPLICATIONS:

- Network & Application Monitoring
- Plug and play on-the-go applications
- Field engineer troubleshooting
- TAP the wire in difficult locations
- Wireshark users who need to collect the packets off the wire

## SOLUTIONS:

FieldTAPs are ideal for:

-  Wireshark
-  Packet Capture
-  Network Analyzer
-  Forensics

## Competitive Edge

- Noiseless operation. No moving parts.
- Portable - A trouble-shooting tool kit must have.
- Tested and Certified



## Have Questions?

sales@garlandtechnology.com  
+716.242.8500  
garlandtechnology.com

# FieldTAP

10M/100M/1000M (1G) | USB monitor ports | Troubleshooting

Model #	Network Speed	Chassis Size	# of TAPs	Supported OS	Network	Monitor	Power
RMP-1U							
P1GCUA	10/100/1000Mbps (1Gbps)	Portable	1	-Windows -Linux -macOS	Copper - RJ45	USB 3.0	USB; DC
P1GCUA_mini	10/100/1000Mbps (1Gbps)	Pocket-size "mini"	1	-Windows -Linux -macOS	Copper - RJ45	USB 3.0	USB; DC
Wall Wart 5V	Wall Wart 5Volt Power Supply						
Blade(INT)	for Wall Wart						

Pocket size mini is not compatible with RMP 1U rack mount.  
 Pocket size mini additional external power supply not included.  
 USB cable included.

## Network Flow

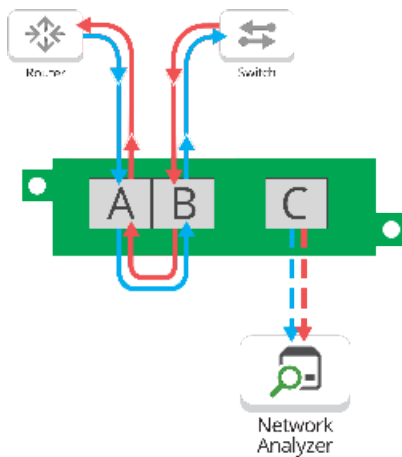

### FieldTAP: USB Mini

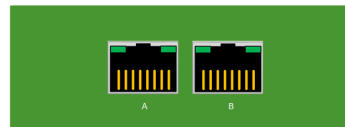

Front - (2) RJ45 Network ports



Back - (1) USB 3.0 Monitor port

## Additional Specifications

**Mini Size Dimensions (HxWxD):** 1" x 2.6" x 5.1"  
 (25.4mm x 66.04mm x 129.54mm)  
**Weight:** 0.45 lbs (0.204 kg)  
**Ambient Temperature:** 0C to +40C / +32F to +104F  
**Storage Temperature:** -20C to +70C / -4F to +158F  
**Voltage:** 5V  
**Current (nominal):** 0.8 Amps  
**Maximum consumption:** 4 Watts  
**Humidity:** 0-90% non-condensing

USB3 data rate = 5Gb/s

**Portable Dimensions (HxWxD):** 1.15" x 3.9" x 6.5"  
 (29.21mm x 99.06mm x 165.10mm)  
**Weight:** 0.71 lbs (0.3175 kg)  
**Ambient Temperature:** 0C to +40C / +32F to +104F  
**Storage Temperature:** -20C to +70C / -4F to +158F  
**Voltage:** 5V  
**Current (nominal):** .8 Amps  
**Maximum consumption:** 4 Watts  
**Humidity:** 0-90% non-condensing

USB3 data rate = 5Gb/s



This document is for informational purposes only. The information in this document, believed by Garland Technology to be accurate as of the date of publication, is subject to change without notice. Garland Technology assumes no responsibility for any errors or omissions in this document and shall have no obligation to you as a result of having made this document available to you or based upon the information it contains. ©2020 Garland Technology LLC. All Rights Reserved